

Digital Flow Switch for Deionized Water and Chemicals

Series PF2D



Body and Sensor

New PFA

Tube

Super PFA

Three types of flow range

- 0.4 to 4 L/min (PF2D504)
- 1.8 to 20 L/min (PF2D520)
- 4.0 to 40 L/min (PF2D540)

A single controller can monitor the flow rate of 4 different sensors.



4-channel Flow Monitor Series PF2D200

Dust generation of 3 particles/cc or less (average number)
 Karman vortex eliminates moving parts and allows low dust generation.

Swept flow characteristics
 Tapered side seal minimizes dead volume to reduce accumulation of liquid pool.

Particle characteristics (reference)

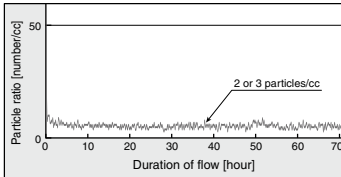

The data was obtained by performing an actual 10 minutes' supersonic cleaning using an average 16 M μ m of deionized water at class 10000 clean room (1 L/min flow rate).
 The diameter of the measured particles ranges from 0.1 to 0.5 μ m. The flow rate used during measuring is 100 cc/min.

Swept flow characteristics (reference)

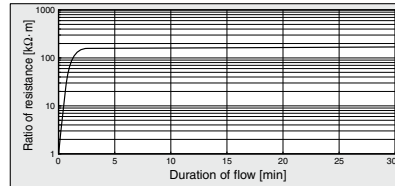

Fill the flow path with sulfuric acid and leave it for 30 minutes.
 After disposing the sulfuric acid, flush the flow path out with deionized water and measure the resistance rate of the fluid that is discharged from the downstream side.
 A quick recovery time indicates little liquid pool.

Processing chart for Series PF2D

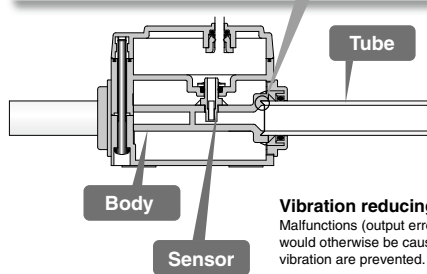
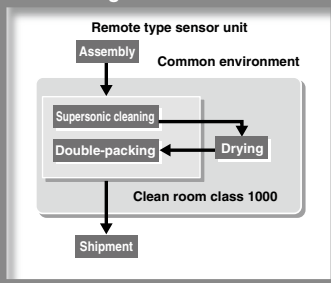

Vibration reducing seals
 Malfunctions (output errors) that would otherwise be caused by vibration are prevented.

- PFM
- PFMV
- PF2A
- PF3W
- PF2D
- IF

For Deionized Water and Chemicals

Digital Flow Switch

Series PF2D



How to Order

Remote Type
Sensor Unit

PF2D5 20 - 13 - 1 - C

Flow rate range

04	0.4 to 4 L/min
20	1.8 to 20 L/min
40	4 to 40 L/min

Port size: (inch)

11	3/8	PF2D504
13	1/2	PF2D520
19	3/4	PF2D540

Option (Refer to page 1077.)

Nii	None
C	e-con connector x 1 pc.

The cable and connector are shipped unassembled.

Output specification

Symbol	Specification	Applicable monitor unit (monitor) model
1	Output for monitor unit + analog output (1 to 5 V)	Series PF2D200/300
2	Output for monitor unit + analog output (4 to 20 mA)	Series PF2D300

Specifications for Sensor Unit

For details about the Flow Switch Precautions, refer to pages 952 and 953. For details about the Specific Product Precautions, refer to the Operation Manual at SMC website.

Model	PF2D504	PF2D520	PF2D540
Measured fluid	Liquid not to corrode nor erode deionized water and/or fluoropolymer. Viscosity: 3mPa·s (3cP) or less		
Detection style	Karman vortex		
Rated flow range	0.4 to 4 L/min	1.8 to 20 L/min ^{Note 1)}	4 to 40 L/min
Operating pressure range ^{Note 2)}	0 to 1 MPa		0 to 0.6 MPa
Proof pressure ^{Note 3)}	1.5 MPa		0.9 MPa
Operating fluid temperature	0 to 90°C		
Accuracy ^{Note 4)}	±2.5% F.S. (at 25°C water)		
Repeatability	±1% F.S. (at 25°C water)		
Temperature characteristics	±5% F.S. (0 to 50°C, based on 25°C)		
Output specifications	Pulse output	Pulse output, N channel, open drain, output for monitor unit PF2D 300/301 (Specifications: Maximum load current of 10 mA; Maximum applied voltage of 30 V)	
	Analog output	Voltage output ^{Note 5)} 1 to 5 V Accuracy: ±2% F.S., Min. load impedance: 100 kΩ (Output impedance: 1 kΩ) Current output ^{Note 6)} 4 to 20 mA Accuracy: ±2% F.S. or less, Max. load impedance: 300 Ω or less with 12 VDC, 600 Ω or less with 24 VDC	
Power supply voltage	12 to 24 VDC ±10%		
Current consumption	20 mA or less (without load)		
Environmental resistance	Enclosure	IP65	
	Operating temperature range	Operating: 0 to 50°C, Stored: -25 to 85°C in stock (with no condensation and freezing)	
	Voltage resistance	1000 VAC for 1 min. between external terminals and case	
	Insulation resistance	50 MΩ or more (500 VDC measured via megohmmeter) between external terminals and case	
Standards	CE, RoHS		
Weight	140 g (without lead wire)		225 g (without lead wire)
Port size	3/8 inch tube	1/2 inch tube	3/4 inch tube
Wetted material	Body: New PFA, Sensor: New PFA, Tube: Super PFA		

- Note 1) 1.6 to 20 L/min (0.1 MPa) with viscosity of 1 mPa·s (1 cP) or less
- Note 2) The operating pressure range drops according to the fluid temperature. See attached graph.
- Note 3) 1.5 times of the maximum operating pressure and varying with fluid temperature.
- Note 4) The system accuracy when combined with PF2D30□.
- Note 5) When the voltage output is selected.
- Note 6) When the current output is selected.
- Note 7) The sensor unit conforms to the CE marking.
- Note 8) For details about wiring, refer to the Operation Manual that can be downloaded from SMC website (<http://www.smcworld.com>).

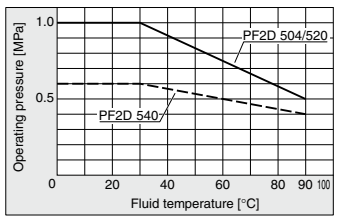

Made to Order

Series LQ1 fluoropolymer fittings mounting type is also available. Refer to page 1078.



For Deionized Water and Chemicals *Series PF2D*

Digital Flow Switch

Series PF2D

How to Order



Remote Type
Monitor Unit

PF2D30 **0** - **A** - **M**

Output specification

0	NPN open collector 2 outputs
1	PNP open collector 2 outputs

Unit specification

Nil	With unit switching function
M	Fixed SI unit (Note)

Note) Fixed units: Real-time flow rate: L/min
Accumulated flow: L

Mounting

A	Panel mounting
---	----------------

Specifications for Monitor Unit

For details about the Flow Switch Precautions, refer to pages 952 and 953. For details about the Specific Product Precautions, refer to the Operation Manual at SMC website.

Model		PF2D300/301		
Flow rate measurement range (Note 1)	0.25 to 4.5 L/min	1.3 to 21.0 L/min	2.5 to 45 L/min	
Set flow rate range (Note 1)	0.25 to 4.5 L/min	1.3 to 21.0 L/min	2.5 to 45 L/min	
Minimum set unit (Note 1)	0.05 L/min	0.1 L/min	0.5 L/min	
Accumulated pulse flow rate exchange value (Pulse width: 50ms) (Note 1)	0.05 L/pulse	0.1 L/pulse	0.5 L/pulse	
(Note 2) Display units	Real-time flow rate	L/min, gal (US)/min		
	Accumulated flow	L, gal (US)		
Accumulated flow range (Note 1)	0 to 999999 L			
Accuracy (Note 3)	±2.5% F.S.			
Repeatability	±0.5% F.S.			
Temperature characteristics	±1% F.S. (15 to 35°C, based on 25°C) ±2% F.S. (0 to 50°C, based on 25°C)			
Current consumption (No load)	60 mA or less			
Weight	45 g			
Note 4) Output specifications	Switch output	NPN open collector (PF2D300)	Maximum load current: 80 mA Internal voltage drop: 1 V or less (with load current of 80 mA) Maximum applied voltage: 30 V 2 outputs	
		PNP open collector (PF2D301)	Maximum load current: 80 mA Internal voltage drop: 1.5 V or less (with load current of 80 mA) 2 outputs	
	Accumulated pulse output	NPN open collector or PNP open collector (same as switch output)		
Environmental resistance	Enclosure	IP40		
	Operating temperature range	Operating: 0 to 50°C, Stored: -25 to 85°C (with no condensation and freezing)		
	Voltage resistance	1000 VAC for 1 min. between external terminal and case		
	Insulation resistance	50 MΩ or more (500 VDC measured via megohmmeter) between external terminal and case		
Standards	CE, RoHS			
Indicator light	3-digits 7-segment LED			
Status LED's	ON: when light is on, OUT1: Green; OUT2: Red			
Power supply voltage	12 to 24 VDC ±10%			
Response time	1sec. or less			
Hysteresis	Hysteresis mode: adjustable (can be set from 0) Window comparator mode (Note 5): fixed (3 digits)			

Note 1) The value varies depending on set flow range

Note 2) For digital flow switch with unit switching function, (Fixed SI unit [L/min or L] will be set for switch types without the unit switching function.)

Note 3) The system accuracy when combined with PF2D5□□□.

Note 4) Switch output and accumulated pulse output can be selected using the control button operation during initial setting.

	1	2	3	4
Output 1	Switch output	Switch output	Accumulated pulse output	Accumulated pulse output
Output 2	Switch output	Accumulated pulse output	Switch output	Accumulated pulse output

Note 5) Window comparator mode: Since hysteresis (H) will reach 3 digits, keep P_1 and P_2 or n_1 and n_2 apart by 7 digits more. (In case of output OUT2, n_1, 2 to be n_3, 4 and P_1, 2 to be P_3, 4.)

Note 6) The monitor unit conforms to the CE marking.

Note 7) Accumulated flow rate is reset when the power supply turns OFF.

Note 8) For details about wiring, refer to the Operation Manual that can be downloaded from SMC website (<http://www.smworld.com>).

PFM

PFMV

PF2A

PF3W

PF2D

IF

How to Order



4-channel Flow Monitor
Remote Type
Monitor Unit

Accessory / Power supply output cable (2 m)

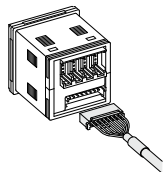

PF2D20 - M

Output specification

0	NPN4 outputs
1	PNP4 outputs

Unit specification

Nil	With unit switching function
M	Fixed SI unit (Note)

Note) Fixed units:
Real-time flow rate: L/min
Accumulated flow: L

Option 2 (Refer to page 1077.)

Nil	None
4C	Sensor connector (4 pc.)

Option 1 (Refer to page 1077.)

Nil	None
A	Panel mounting
B	Front protective cover + Panel mounting

Connectable remote type sensor part is PF2D50--1 (with analog output 1 to 5 V).

For details about the Flow Switch Precautions, refer to pages 952 and 953. For details about the Specific Product Precautions, refer to the Operation Manual at SMC website.

Specifications

Model		PF2D200/201		
Applicable flow rate sensor	PF2D504- <input type="checkbox"/> -1	PF2D520- <input type="checkbox"/> -1	PF2D540- <input type="checkbox"/> -1	
Flow rate measurement range (Note 1)	0.25 to 4.50 L/min	1.3 to 21.0 L/min	2.5 to 45.0 L/min	
Set flow rate range (Note 1)	0.25 to 4.50 L/min	1.3 to 21.0 L/min	2.5 to 45.0 L/min	
Minimum set unit (Note 1)	0.05 L/min	0.1 L/min	0.5 L/min	
Accumulated pulse flow rate exchange value (Pulse width: 50ms) (Note 1)	0.05 L/pulse	0.1 L/pulse	0.5 L/pulse	
Display units (Note 1)	Real-time flow rate	L/min, gal (US)/min		
	Accumulated flow	L, gal (US)		
Accumulated flow range (Note 1)	0 to 999999 L, 0 to 999999 gal (US)			
Power supply voltage	24 VDC \pm 10% (With power supply polarity protection)			
Current consumption	55 mA or less (Not including the current consumption of the sensor)			
Power supply voltage for sensor	Same as [Power supply voltage]			
Power supply current for sensor (Note 2)	Max. 110 mA (However, the total current for the 4 inputs is 440 mA maximum or less.)			
Sensor input	1 to 5 VDC (Input impedance: Approx. 800K Ω)			
Output specifications (Note 3)	No. of inputs	4 inputs		
	Input protection	Excess voltage protection		
	Switch output (Real-time switch output, Accumulated switch output)	NPN open collector (PF2D200)	Maximum load current: 80 mA Internal voltage drop: 1 V or less (with load current of 80 mA) Maximum applied voltage: 30 V	
		PNP open collector (PF2D201)	Maximum load current: 80 mA Internal voltage drop: 1 V or less (with load current of 80 mA)	
	Accumulated pulse output	NPN open collector or PNP open collector (same as switch output)		
	No. of outputs	4 outputs (1 output per 1 sensor input)		
	Output protection	Short circuit protection		
Hysteresis	Hysteresis mode: Variable (can be set from 0), Window comparator mode: Fixed (3-digits)			
Response time (Note 4)	1s or less			
Accuracy (Note 4)	\pm 5% F.S.			
Repeatability (Note 4)	\pm 3% F.S.			
Temperature characteristics	\pm 2% F.S. (0 to 50°C, based on 25°C)			
Display method	For measured value display: 4-digits, 7-segment LED (Orange) For channel display: 1-digit, 7-segment LED (Red)			
Status LED's	Illuminates when output is ON OUT1: Red			
Enclosure	IP65 for the front face only, the rest is IP40.			
Operating temperature range	Operating: 0 to 50°C, Stored: -10 to 60°C (with no freezing and condensation)			
Operating humidity range	Operating or Stored: 35 to 85%RH (with no condensation)			
Standards	CE, RoHS			
Connection	Power supply / Output connection: 8P connector, Sensor connection: 4P connector (e-con)			
Material	Housing: PBT, Monitor: PET, Backside rubber: CR			
Weight	60 g (Except for any accessories that are shipped together.)			

Note 1) Fixed SI unit [L/min or L] will be set for switch types without the unit switching function. ("M" is suffixed at the end of part number.) Accumulated flow is reset when the power supply turns OFF.

Note 2) If Vcc side on sensor input connector part is short-circuited with the 0V side, the flow monitor inside will be damaged.

Note 3) Switch output and accumulated pulse output can be selected during initial setting.

Note 4) The system accuracy when combined with an applicable flow sensor.

Note 5) This product conforms to the CE marking.

Note 6) For details about wiring, refer to the Operation Manual that can be downloaded from SMC website (<http://www.smcworld.com>).

Set Flow Rate Range and Rated Flow Range

Set the flow rate within the rated flow range.

The set flow rate range is the range of flow rate that can be set on the controller.

The rated flow range is the range that satisfies the sensor's specifications (accuracy, linearity etc.).

It is possible to set a value outside of the rated flow range, however, the specification is not guaranteed.

Sensor	Flow rate range					
	0.4L/min	1.8L/min	4L/min	10L/min	20L/min	40L/min
PF2D504	Rated flow range of sensor (0.4L/min to 4L/min)			Set flow rate range of sensor (0.25L/min to 4.5L/min)		
	Rated flow range of sensor (1.8L/min to 20L/min)			Set flow rate range of sensor (1.3L/min to 21L/min)		
PF2D540	Rated flow range of sensor (4L/min to 40L/min)					
	Set flow rate range of sensor (2.5L/min to 45L/min)					

Flow Characteristics (Pressure Characteristics)

PF2D504

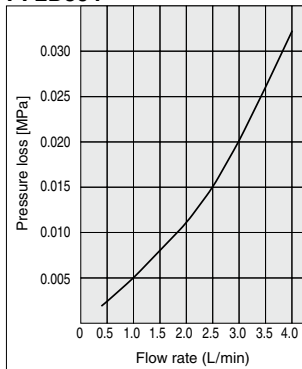

PF2D520

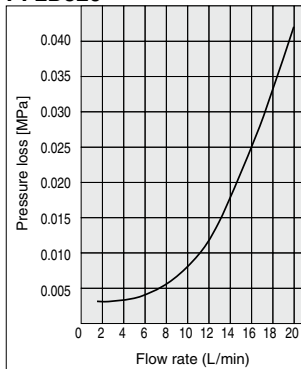

PF2D540

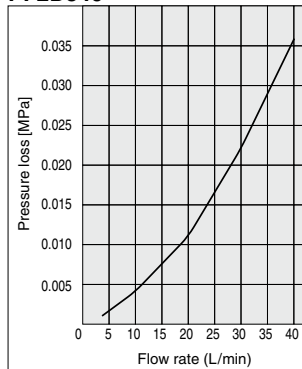

Construction

PF2D504/520

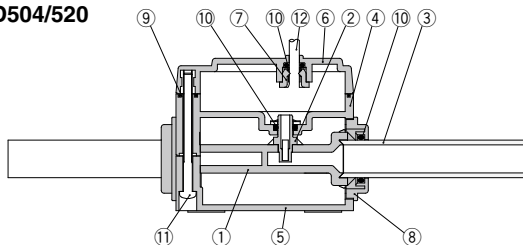

PF2D540

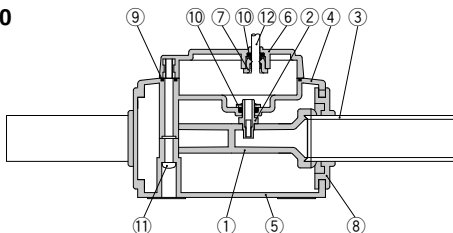

Parts list

Number	Parts	Material
1	Body	New PFA
2	Sensor	New PFA
3	Tube	Super PFA
4	Housing A	PPS
5	Housing B	PPS
6	Housing C	PPS
7	Bushing	POM
8	Cap	PPS
9	Gasket	FKM
10	O-ring	FKM
11	Thread	Stainless steel 304
12	Lead wire	PVC

PFM

PFMV

PF2A

PF3W

PF2D

IF

Series PF2D

Dimensions: Remote Type Sensor Unit

PF2D504-11/520-13

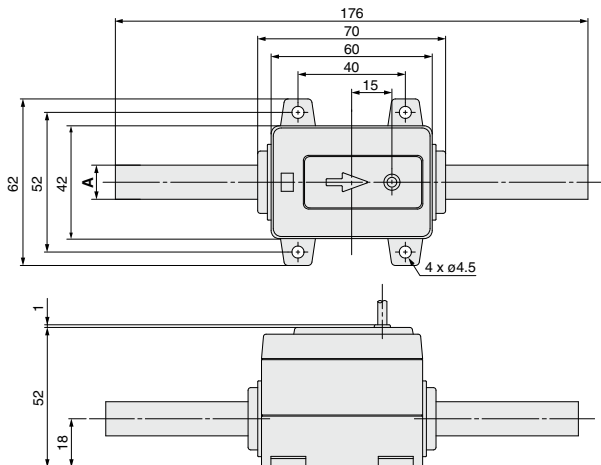

Model	A
PF2D504	ø9.52
PF2D520	ø12.7

PF2D540-19

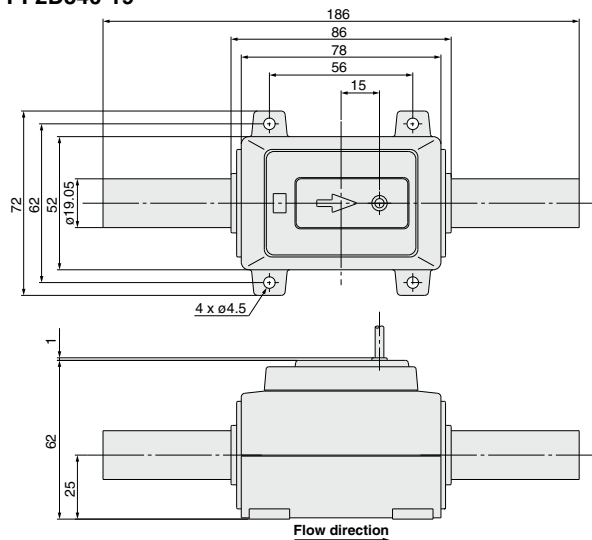

Analog output

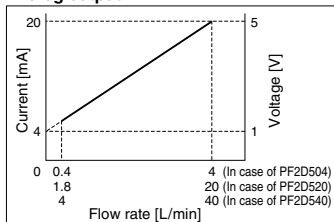

Cable Specifications

No. of cable wire	4	
Conductor	Nominal cross-sectional area	0.15 mm ²
	Dimension	Approx. 0.5 mm
Insulator	Dimension	Approx. 0.9 mm Brown, White, Blue, Black
	Material	Oil-resistant PVC
Sheath	O.D.	3.5mm

Dimensions: Remote Type Monitor Unit

PF2D30[†]-A

Panel mounting type

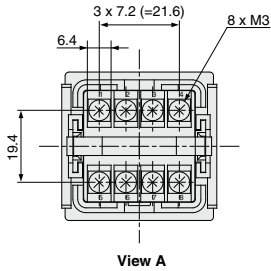
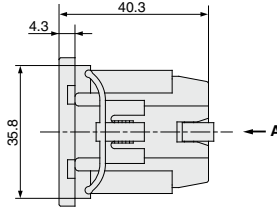
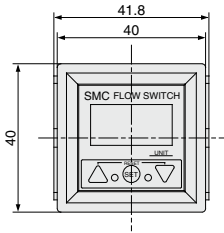

Panel fitting dimensions

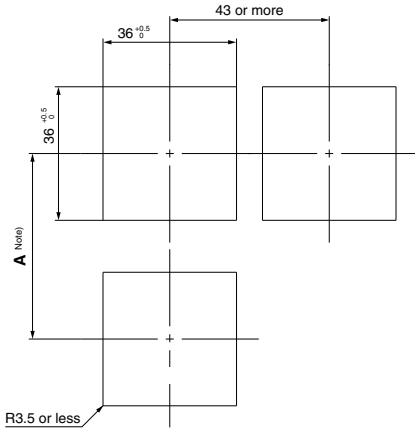

Note) Decide the length of A taking into account the size of terminal you use.
 * The applicable panel thickness is 1 to 3.2 mm.
 Corner: R3.5 or less

PFM
PFMV
PF2A
PF3W
PF2D
IF

Series PF2D

Dimensions: Remote Type Monitor Unit **for Deionized Water and Chemicals** (4-channel Controller)

PF2D200/201

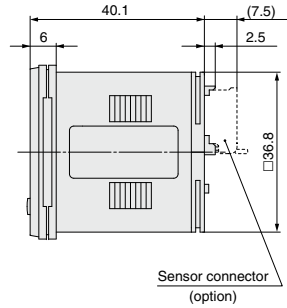
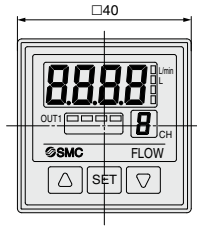

Front protective cover + Panel mounting

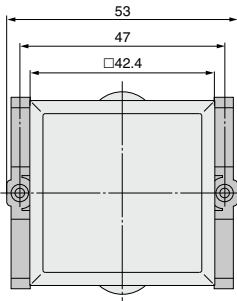

Panel fitting dimensions

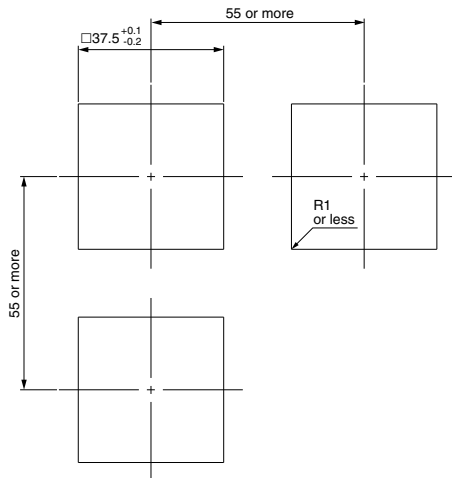
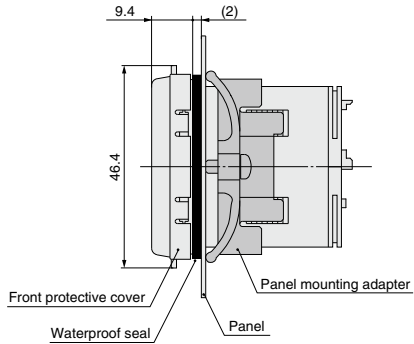

* Applicable panel thickness: 0.5 to 8 mm

Dimensions: Remote Type Monitor Unit for Deionized Water and Chemicals (4-channel Controller)

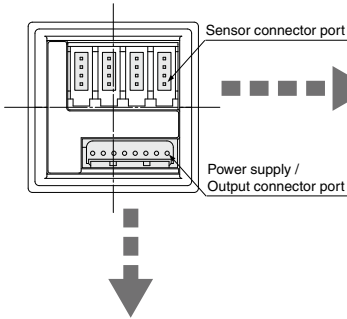

Sensor connector (4P x 4)



Connector (option)

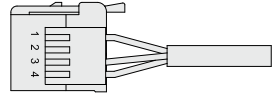

Pin no.	Terminal	Connector no.	Cable wire color
①	DC+	1	Brown
②	N.C.	2	Not used
③	DC-	3	Blue
④	IN: 1 to 5 V	4	White

Power supply / Output connector (8P)

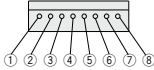

Pin no.	Terminal
①	DC (+)
②	DC (-)
③	CH1_OUT1
④	N.C.
⑤	CH2_OUT1
⑥	CH3_OUT1
⑦	CH4_OUT1
⑧	N.C.

Power supply / Output connector (accessory)

Pin no.

- 8 Yellow N.C.
- 7 Green CH4_OUT1
- 6 Red CH3_OUT1
- 5 Gray CH2_OUT1
- 4 White N.C.
- 3 Black CH1_OUT1
- 2 Blue DC(-)
- 1 Brown DC(+)

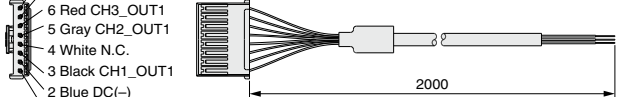

Cable Specifications

No. of cable wire	8	
Conductor	Nominal cross-sectional area	0.15 mm ²
	Dimension	Approx. 0.5 mm
Insulator	Dimension	Approx. 0.9 mm Brown, White, Blue, Black, Gray, Red, Green Yellow
Sheath	Material	Heat-resistant polyethylene
	O.D.	4.8 mm

PFM

PFMV

PF2A

PF3W

PF2D

IF

Flow rate measurement selection

Real-time flow rate and accumulated flow rate can be selected. A flow rate of up to 999999 can be accumulated. The accumulated flow rate is reset when the power supply turns OFF.

Unit switching

Display	Real-time flow rate	Accumulated flow
\dot{V}_1	L/min	L
\dot{V}_2	GPM	gal (US)

GPM = gal (US)/min

Note) Fixed SI unit (L/min, L, m³ or m³×10) will be set for the type without the unit switching function.

Flow rate measuring unit confirmation

This function allows to confirm the accumulated flow rate when real-time flow rate is selected and to confirm the real-time flow rate when accumulated flow rate is selected.

Error correction

For PF2D300/301

LED display	Contents	Solution
Er1	A current of more than 80 mA is flowing to OUT1.	Check the load and the wiring for OUT1.
Er2	A current of more than 80 mA is flowing to OUT2.	Check the load and the wiring for OUT2.
Er4	The set data has changed for some reason.	Perform the RESET operation, and reset all the data again.
---	The flow rate is over the flow rate measurement range.	Use an adjustment valve, etc. to reduce the flow rate until it is within the flow rate range.

For PF2D200/201

LED display	Contents	Solution
Er1	Over current is flowing to the load of a switch output.	Shut off the power supply. After eliminating the output factor that caused the excess current, turn the power supply back on.
Er0	Internal data error.	Contact SMC.
Er7	Internal data error.	
Er10	Internal data error.	
Er5	Internal data error.	Shut off the power supply and then reset the switch.
Er6	Internal data error.	
---	The flow rate is over the flow rate measurement range.	Use an adjustment valve, etc. to reduce the flow rate until it is within the flow rate range.

Key lock

This function prevents incorrect operations such as changing the set value accidentally.

Accumulation clearance

This is to clear the accumulated value.

Output types

Real-time switch output, accumulated switch output, or accumulated pulse output can be selected as an output type.

Real-time switch output

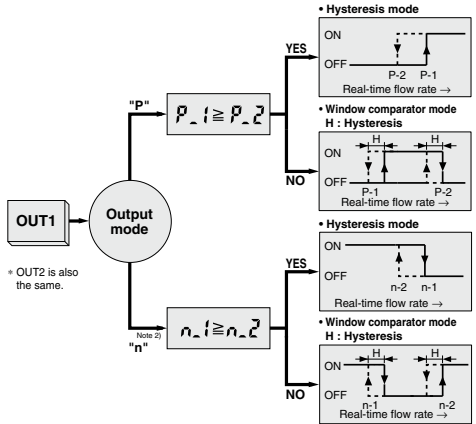

Note 2) Output mode is set to inverted output at the factory before shipment.

Accumulated switch output

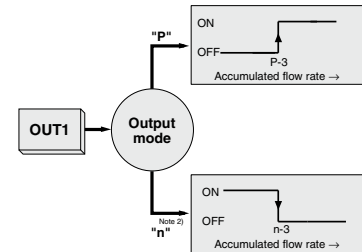

Note 2) Output mode is set to inverted output at the factory before shipment.

Accumulated pulse output

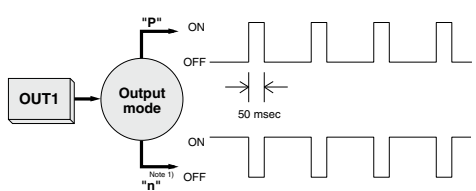

Note 1) Refer to the specifications of monitor unit for the flow rate value per pulse.

Functions

Copy function (PF2D200, 201 only)

Information to be copied is:

- ① Flow rate range
- ② Display mode
- ③ Display unit (Only available when the unit specification is nil.)
- ④ Output method
- ⑤ Output mode
- ⑥ Flow rate value

Peak hold, Bottom hold display function

(PF2D200, 201 only)

The maximum or minimum value can be held in the case where the real-time flow rate display mode is selected during the initial setting. The hold value is reset when the power supply turns OFF or the hold is released.

Channel select function (PF2D200, 201 only)

Every pushing the Δ button, channel selection "1→2→3→4→1..." is available. The flow rate measurement of each selected channel is shown in the monitor unit.

Channel scan function (PF2D200, 201 only)

Changes displaying the channel shown every about 2 seconds and its detected flow rate.

Option

When only optional parts are required, order with the part numbers listed below.

e-con connector

Part no.	Qty.
ZS-28-CA-2	1

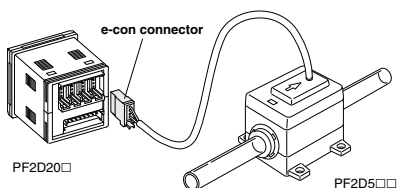

In addition to the connector shown above, those listed below (female contact) can be connected.

Manufacturer	Model
Sumitomo 3M Limited	37104-3101-000FL
Tyco Electronics Japan G.K.	1-1473562-4
OMRON Corp.	XN2A-1430

Panel mounting

Pin no.	Description	Note
ZS-22-E	Panel mounting adapter A, B	With mounting bracket

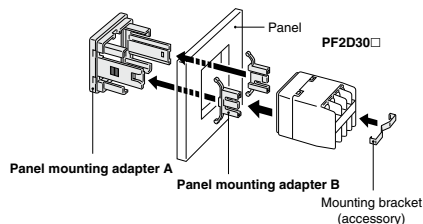

Part no.	Description	Note
ZS-26-B	Panel mounting adapter	With waterproof seal, mounting screw
ZS-26-C	Front protective cover + Panel mounting adapter	With waterproof seal, mounting screw

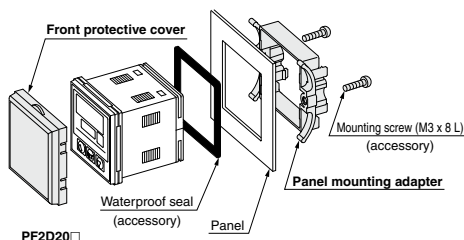

PFM

PFMW

PF2A

PF3W

PF2D

IF

Series PF2D5 Made to Order

Please contact SMC for detailed dimensions, specifications, and lead times.



1 Fluoropolymer fittings mounting type (Space saving type)

Attached insert bushings and nuts for LQ1 series fluoropolymer fittings on double end piping.

How to Order

Refer to page 1068 for details about How to Order.

PF2D504 S - 11 - - - 1S

With LQ1 fitting

Size

Model	IN side	OUT side
11	3	3
1113	3	4 (With reducer)
1311	4 (With reducer)	3
13	4 (With reducer)	4 (With reducer)

PF2D520 S - 13 - - - 1S

With LQ1 fitting

Size

Model	IN side	OUT side
13	4	4
1319	4	5 (With reducer)
1913	5 (With reducer)	4
19	5 (With reducer)	5 (With reducer)

PF2D540 S - 19 - - - 1S

With LQ1 fitting

Size

Model	IN side	OUT side
19	5	5
1925	5	6 (With reducer)
2519	6 (With reducer)	5
25	6 (With reducer)	6 (With reducer)

Dimensions

External dimensions of the body are the same as those of standard products. Refer to page 1072.

LQ1 fitting size: 3

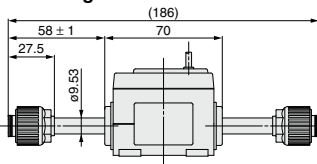

LQ1 fitting size: 4

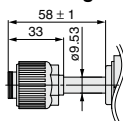

LQ1 fitting size: 4

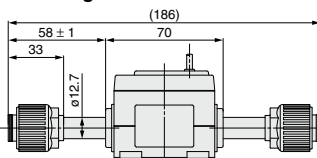

LQ1 fitting size: 5

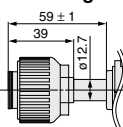

LQ1 fitting size: 5

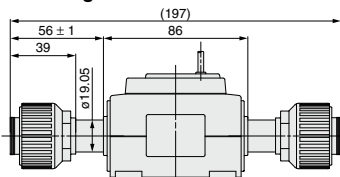

LQ1 fitting size: 6

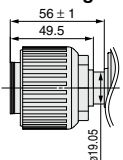

Made to Order Related Products



How to Order Fittings for a Product with Nuts

How to order a flow sensor, PF2D5□S series, etc. nut type fittings without a nut (including insert bushings) in one place.

LQ1 **E** 21 - SN

Fitting type

• Nut type fittings without a nut (including insert bushings) in one place

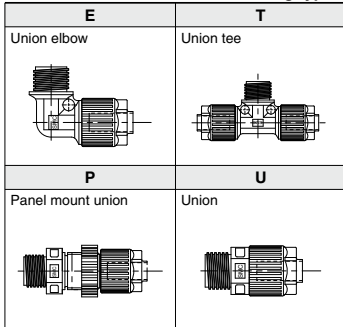

• Applicable tubing size

Class	No.	Applicable tubing size (mm)	Reducing
3	1	10 x 8	○
3	2	8 x 6	●
3	3	6 x 4	●
4	1	12 x 10	○
4	2	10 x 8	●
5	1	19 x 16	○
5	2	12 x 10	●
6	1	25 x 22	○
6	2	19 x 16	●

Class	No.	Applicable tubing size (inch)	Reducing
3	A	3/8" x 1/4"	○
3	B	1/4" x 5/32"	●
4	A	1/2" x 3/8"	○
4	B	3/8" x 1/4"	●
5	A	3/4" x 5/8"	○
5	B	1/2" x 3/8"	●
6	A	1" x 7/8"	○
6	B	3/4" x 5/8"	●

○: Basic size ●: With reducer

Note) Please select an isometric fitting with the same size as the fitting at the flow sensor.

Order example

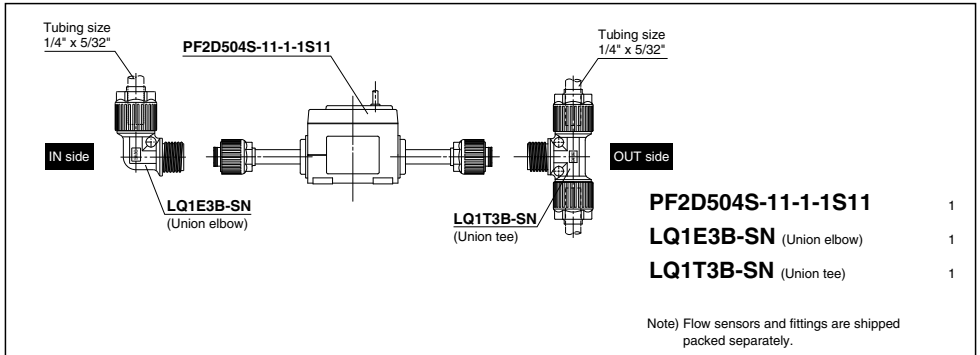

PFM

PFMV

PF2A

PF3W

PF2D

IF



Series PF2D

Applicable Fluid

Compatibility checklist: Between the digital flow switch sensor material for deionized water and chemicals and the fluid selected.

Fluid	Compatibility
Acetone	○
Ammonium hydroxide Concentration 30% or less	○
Isobutyl alcohol	×
Isopropyl alcohol	○
Hydrochloric acid Concentration 38% or less	○
Ozone	×
Hydrogen peroxide Concentration 50% or less 50°C or less	○
Ethyl acetate	○
Butyl acetate	○
Nitric acid (except fuming nitric acid) Concentration 10% or less	○
Deionized water	○
Sodium hydroxide	×
Ultra deionized water	○
Toluene	○
Hydrofluoric acid Concentration 50% or less	○
Sulfuric acid (except fuming sulfuric acid) Concentration 20% or less	○
Phosphoric acid Concentration 30% or less	○

Note 1) The material and fluid compatibility check list provides reference values as a guide only.

Note 2) It is possible that some fluids are permeable depending on the type of fluid, its density and temperature. Any permeated fluid may affect the products life.

Thus, when using these fluid types, verify the fluid in advance by testing it, prior to making a decision to use it.

- Compatibility is indicated for fluid temperatures at 90°C or less.
- The product does not have an explosion proof construction. Be sure to take measures to prevent the area around the product from becoming filled with an explosive gas, when using an explosive fluid.

Table symbols ○ : Can be used
○ : Can be used under certain conditions
× : Cannot be used